

Model Number : LF-PK35W02A

Frequency Range (Hz) : 500~10K

Capacitance (at 120 Hz 25°C) : 180nF \pm 0.00%

Sound Pressure Level

(dB min.) 10cm : 75dB min. 630KHz

Input Voltage (Vp-p) (max) : 7V rms (sine wave)

Operating Temp. (°C) : -20 ~ +80

Weight (gms) : 0.9

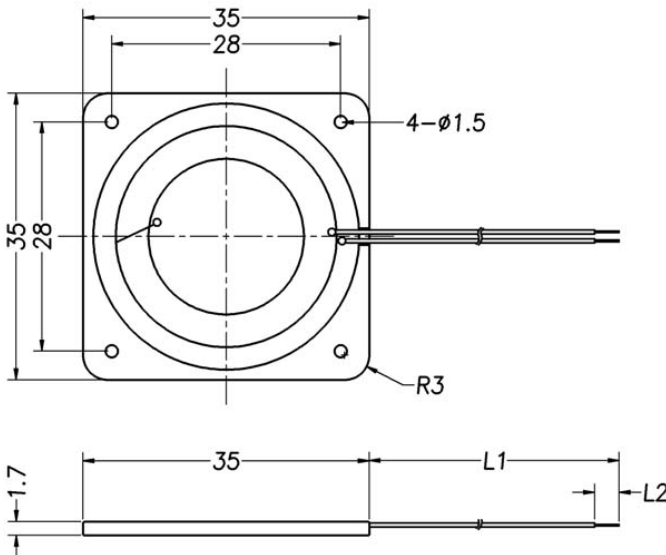

PK35W02A 1Vrms sine wave test by close box 3440cc
X:630.00Hz *Y:79.93dB ZA:1.0000 SSR Fund.

